



PLEASE READ CAREFULLY
and save this document
CONSIDER THE ENVIRONMENT

EN ENGLISH

- power supply 230 VAC or 12-24 VAC/DC (according to the model)
- multi-sensor input (PTC/NTC/J/K/Pt 100/Pt 1000/Ni 120/0-20 mA/4-20 mA/0-10 V/2-10 V)
- multi-purpose input
- analogue output 0-10V/PWM (alternatively to relay K1)
- K1 relay 16 A res. @ 250 VAC (alternatively to the analog output)
- alarm buzzer
- TTL MODBUS slave port for programming key, for EVlink BLE module (app EVconnect) or for TTL/RS-485 (BMS) serial interface
- on-off/PID control
- hot or cold mode regulation.

1 MEASUREMENTS AND INSTALLATION

Measurements in mm (in): 59.0 (2 5/16) depth with fixed screw terminal blocks, 81.5 (3 3/16) depth with plug-in screw terminal blocks.
To be fitted to a panel, snap-in brackets provided.

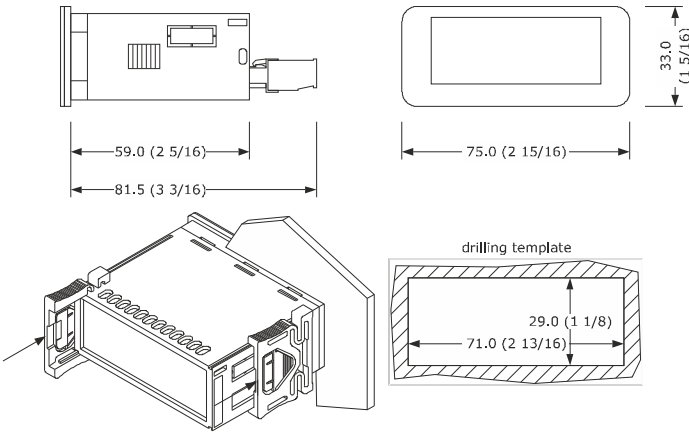

INSTALLATION PRECAUTIONS

- the thickness of the panel must be between 0.8 and 2.0 mm (1/32 and 1/16 in);
- ensure that the working conditions are within the limits stated in the *TECHNICAL SPECIFICATIONS* section;
- do not install the device close to heat sources, equipment with a strong magnetic field, in places subject to direct sunlight, rain, damp, excessive dust, mechanical vibrations or shocks;
- in compliance with safety regulations, the device must be installed properly to ensure adequate protection from contact with electrical parts. All protective parts must be fixed in such a way as to need the aid of a tool to remove them.

2 ELECTRICAL CONNECTION

- N.B.
- use cables of an adequate section for the current running through them.
 - ensure that the thermocouple is properly insulated from contact with metal parts or use already insulated thermocouples.
 - if necessary, extend the thermocouple cable using a compensating cable.
 - in the models with power supply 12-24 VAC/DC, the analog output is available on condition that the device is powered at 24 VAC/DC.
 - to reduce any electromagnetic interference locate the power cables as far away as possible from the signal cables.

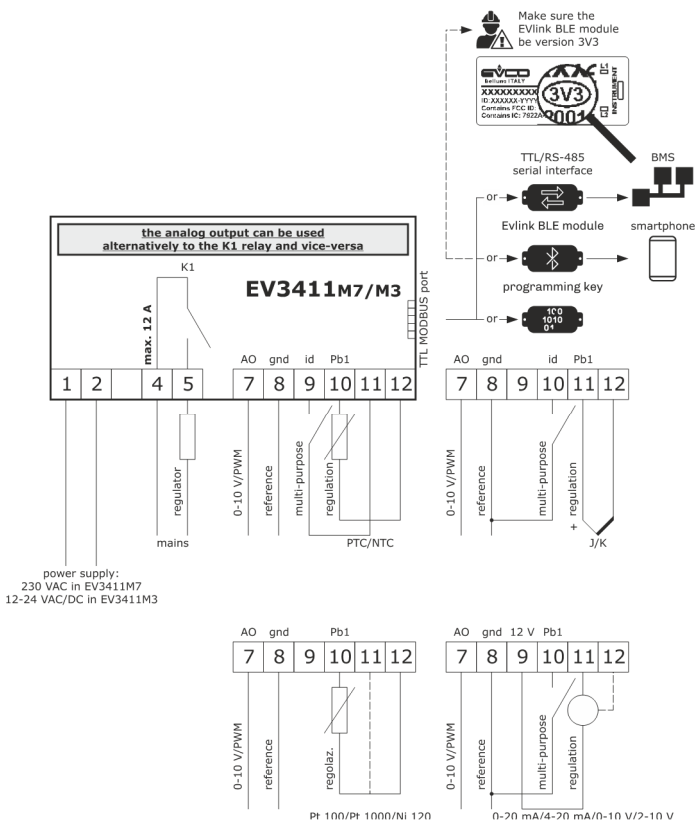

PRECAUTIONS FOR ELECTRICAL CONNECTION

- If using an electrical or pneumatic screwdriver, adjust the tightening torque;
- if the device has been moved from a cold to a warm place, humidity may have caused condensation to form inside. Wait about an hour before switching on the power;
- make sure that the supply voltage, electrical frequency and power are within the set limits. See the section *TECHNICAL SPECIFICATIONS*;
- disconnect the power supply before carrying out any type of maintenance;
- do not use the device as safety device;
- for repairs and for further information, contact the EVCO sales network.

3 FIRST-TIME USE

1. Install following the instructions given in the section *MEASUREMENTS AND INSTALLATION*.
2. Power up the device as set out in the section *ELECTRICAL CONNECTION*: an internal test will start up. The test normally takes a few seconds; when it is finished the display will switch off.
3. Configure the device as shown in the section *Setting configuration parameters*. Recommended configuration parameters for first-time use.

PAR.	DEF.	PARAMETER	MIN... MAX.
SP	0.0	setpoint	r1... r2

P0	2	type of probe	0 = PTC 1 = NTC 2 = J 3 = K 4 = Pt 100 3 wires 5 = Pt 100 3 wires 6 = Pt 1000 3 wires 7 = Pt 1000 3 wires 8 = 4-20 mA 9 = 0-20 mA 10 = 2-10 V 11 = 0-10 V 12 = Ni 120 3 wires 13 = Ni 120 2 wires
P2	0	temperature measurement unit	0 = °C 1 = °F
r5	0	hot or cold mode regulation regulator	0 = cold mode 1 = hot mode
uA	0	outputs configuration	0 = analog output not enabled, K1 relay with regulator 1 = analog output proportional to the regulation temperature, K1 relay not enabled 2 = analog output with regulator, K1 relay not enabled
ub	0	type of analogue output	0 = 0-10 V 1 = PWM

- Then check that the remaining settings are appropriate; see the section *CONFIGURATION PARAMETERS*.
Disconnect the device from the mains.
4. Make the electrical connection as shown in the section *ELECTRICAL CONNECTION* without powering up the device.
5. When connecting to an RS-485 network, connect the EVIF22TSX interface. To use the device with the Evconnect app, connect the EVIF25TBX module; see the relative instruction sheets. **If using EVIF22TSX, set the ble parameter to 0.**
6. Power up the device.

4 USER INTERFACE AND MAIN FUNCTIONS

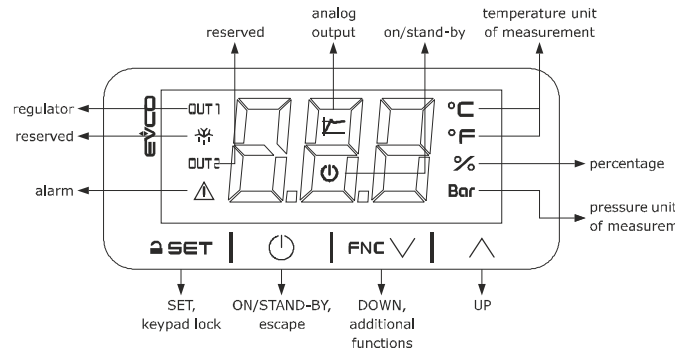

4.1 Switching the device on/off

1. If POF = 1 (default), touch the ON/STAND-BY key for 4s.
If the device is switched on, the display will show the P5 value ("regulation temperature" default); if the display shows an alarm code, see the section *ALARMS*.

LED	ON	OFF	FLASHING
OUT1	regulator active	-	- regulator protection active - setpoint being set
⚡	unused	-	-
OUT2	unused	-	-
⚠	alarm active	-	-
⚡	analogue output active	-	-
⏻	device switched off	device switched on	device being switched on/off
°C/°F	temperature display	-	-
%	percentage display	-	-
Bar	pressure display	-	-

When 30s have elapsed without the keys being pressed, the display will show the "Loc" label and the keypad will lock automatically.

4.2 Unlocking the keypad

Touch a key for 1s: the display will show the label "UnL".

4.3 Setting the setpoint

- Check that the keypad is not locked.
1. Touch the SET key: the display will show the label "SP".
 2. Touch the UP or DOWN key within 15s to set the value within the limits r1 and r2 (default "0... 350").
 3. Touch the SET key (or take no action for 15s).

4.4 Silencing the buzzer (if A13 = 1)

Touch a key.

5 FUNCTION MODES

Cold mode regulation (r5 = 0).

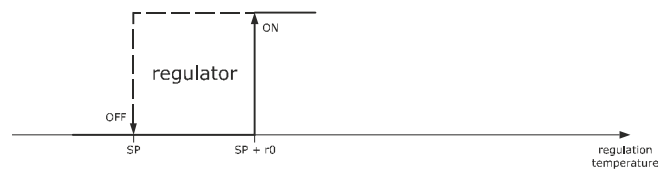

Hot mode regulation (r5 = 1).

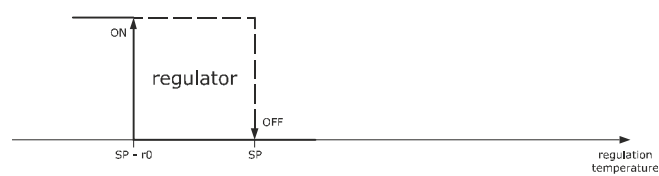

Operation with analogue output 0-10 V (ub = 0, default) proportional to the regulation temperature (ua = 1, default).

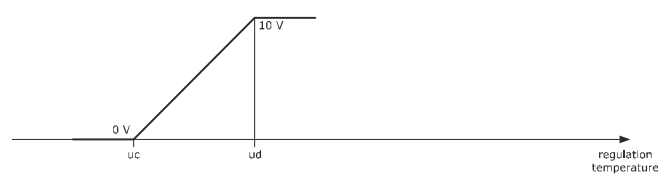

Operation with analogue output PWM (ub = 1) proportional to the regulation temperature (ua = 1, default).

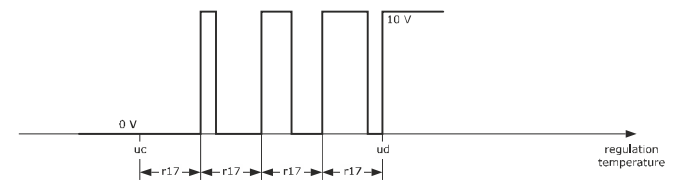

6 ADDITIONAL FUNCTIONS

6.1 Displaying/setting the value delivered by the analogue output

Check that the keypad is not locked.

1. Touch the DOWN key for 4s.
 2. Touch the UP or DOWN key within 15s to select a label.
- | LAB. | DESCRIPTION |
|------|---|
| uA | displaying the value delivered by the analogue output |
| uM | modifying the value delivered by the analogue output |
3. Touch the SET key.
 4. Touch the UP or DOWN key to set the value (to select uM).
 5. Touch the SET key.
 6. Touch the ON/STAND-BY key (or take no action for 60s) to exit the procedure.

6.2 Displaying the number of start-ups of the relay

Check that the keypad is not locked.

1. Touch the DOWN key for 4s.
 2. Touch the UP or DOWN key within 15s to select a label.
- | LAB. | DESCRIPTION |
|------|---|
| nS1 | display of the number of start-ups of the K1 relay in thousands |
3. Touch the SET key.
 4. Touch the ON/STAND-BY key (or take no action for 60s) to exit the procedure.

6.3 Displaying the temperature detected by the regulation probe

Check that the keypad is not locked.

1. Touch the DOWN key for 4s.
 2. Touch the UP or DOWN key within 15s to select a label.
- | LAB. | DESCRIPTION |
|------|------------------------|
| Pb1 | regulation temperature |
3. Touch the SET key.
 4. Touch the ON/STAND-BY key (or take no action for 60s) to exit the procedure.

7 SETTINGS

7.1 Setting configuration parameters

- N.B.
Changing parameter P2 from °C to °F (and vice versa) causes the value of the parameters whose unit of measurement is °C or °F to be changed automatically.

1. Touch the SET key for 4s: the display will show the label "PA".
2. Touch the SET key.
3. Touch the UP or DOWN key within 15s to set the PAS value (default "-19").
4. Touch the SET key (or take no action for 15s): the display will show the label "SP".
5. Touch the UP or DOWN key to select a parameter.
6. Touch the SET key.
7. Touch the UP or DOWN key within 15s to set the value.
8. Touch the SET key (or take no action for 15s).
9. Touch the SET key for 4s (or take no action for 60s) to exit the procedure.

7.2 Restoring factory settings (default) and saving customised settings

- N.B.
- Check that the factory settings are appropriate; see the section *CONFIGURATION PARAMETERS*.
- Saving customised settings overwrites the factory settings.

1. Touch the SET key for 4s: the display will show the label "PA".
2. Touch the SET key.
3. Touch the UP or DOWN key within 15s to set the value.

VAL.	DESCRIPTION
149	value for restoring the factory information (default)
161	value for saving customised settings

4. Touch the SET key (or take no action for 15s): the display will show the label "dEF" (for setting the "149" value) or the label "MAP" (for setting the "161" value)
5. Touch the SET key.
6. Touch the UP or DOWN key within 15s to set "1".
7. Touch the SET key (or take no action for 15s): the display will show "- - -" flashing for 4s, after which the device will exit the procedure.
8. Disconnect the device from the power supply.
9. Touch the SET key for 2s before action 6 to exit the procedure beforehand.

8 CONFIGURATION PARAMETERS

N.	PAR.	DEF.	SETPOINT	MIN... MAX.
1	SP	0.0	setpoint	r1... r2
N.	PAR.	DEF.	ANALOGUE INPUTS	MIN... MAX.
2	CA1	0.0	regulation probe offset	-25... 25 °C/°F
3	P0	2	type of probe	0 = PTC 1 = NTC 2 = J 3 = K 4 = Pt 100 3 wires 5 = Pt 100 2 wires 6 = Pt 1000 3 wires 7 = Pt 1000 2 wires 8 = 4-20 mA 9 = 0-20 mA 10 = 2-10 V 11 = 0-10 V 12 = Ni 120 3 wires 13 = Ni 120 2 wires

4	P1	0	enable decimal point °C	0 = no 1 = yes if P0 = 2 or 3, not effective if P0 = 8... 11, position of decimal point: 0 = none 1 = tens digit
5	P2	0	measurement unit	0 = °C 1 = °F 2 = % 3 = bar 4 = none options 2... 4 effective only on LEDs and if P0 = 8... 11
6	P3	0.0	minimum transducer calibration value	-199... 999 points
7	P4	100	maximum transducer calibration value	-199... 999 points
8	P5	0	value displayed	0 = regulation temperature 1 = setpoint
9	P8	5	display refresh time	0... 250 s : 10
N.	PAR.	DEF.	DIGITAL OUTPUTS	MIN... MAX.
10	uA	0	outputs configuration	0 = analog output not enabled, K1 relay with regulator 1 = analog output proportional to the regulation temperature, K1 relay not enabled 2 = analog output with regulator, K1 relay not enabled
11	ub	0	type of analogue output	0 = 0-10 V 1 = PWM
12	uc	0.0	regulation temperature for minimum analogue output value	-199... ud °C/°F/points
13	ud	100	regulation temperature for maximum analogue output value	uc... 199 °C/°F/points
N.	PAR.	DEF.	REGULATION	MIN... MAX.
14	rA	0	PID control configuration	0 = off 1 = on
15	r0	2.0	setpoint differential	1... 99 °C/°F
16	r1	0.0	minimum setpoint	-199 °C/°F... r2
17	r2	350	maximum setpoint	r1... 999 °C/°F
18	r5	0	hot or cold mode regulation regulator	0 = cold mode 1 = hot mode
19	r11	0.0	digital input second setpoint	-199... 999 °C/°F setpoint + r11
20	r14	50	proportional band	1... 999 °C/°F
21	r15	60	integral action time	0... 999 s
22	r16	30	derivative action time	0... 999 s
23	r17	180	PID regulator cycle time on PWM relay or analogue output	1... 999 s
24	r18	0	PID regulator minimum time on on PWM relay or analogue output	0... 240 s
25	r19	0	PID regulator minimum time off on PWM relay or analogue output	0... 240 s
N.	PAR.	DEF.	REGULATOR PROTECTION	MIN... MAX.
26	C1	0	minimum time between two power-ons of regulator	0... 240 min
27	C2	0	minimum time off and delay from power-on of regulator	0... 240 min
28	C3	0	minimum time on regulator	0... 240 s
29	C4	0	regulator activity during regulation probe alarm	0 = off 1 = on
N.	PAR.	DEF.	ALARMS	MIN... MAX.
30	A1	0.0	temperature alarm threshold	-199... 999 °C/°F
31	A2	0	temperature alarm type	0 = disabled 1 = absolute minimum 2 = absolute maximum 3 = minimum relative to SP 4 = maximum relative to SP
32	A3	0	temperature alarm delay	0... 999 min
33	A7	0	temperature alarm delay after modifying setpoint and power-on	0... 999 min
34	A8	0	additional alarm signal delay after silencing if the condition persists	0... 999 min
35	A11	2.0	temperature alarm switch off differential	1... 99 °C/°F
36	A13	1	enable alarm buzzer	0 = no 1 = yes
N.	PAR.	DEF.	DIGITAL INPUTS	MIN... MAX.
37	i5	0	multi-purpose input function	0 = disabled 1 = alarm iA 2 = alarm iA + regulator off 3 = switches device on/off 4 = modifies setpoint
38	i6	0	multi-purpose input activation	0 = with contact closed 1 = with contact open
39	i7	0	multi-purpose input alarm delay	0... 999 s
N.	PAR.	DEF.	SECURITY	MIN... MAX.
40	POF	1	enable ON/STAND-BY key	0 = no 1 = yes
41	PAS	-19	password	-99... 999
42	PA1	426	1 st level password	-99... 999
43	PA2	824	2 nd level password	-99... 999
N.	PAR.	DEF.	EVLINK DATA-LOGGING	MIN... MAX.
44	bLE	1	serial port configuration for connectivity	0 = free 1 = forced for EVconnect or EPoCA 2-99 = EPoCA local network address
45	rEO	15	datalogger sampling interval	0... 240 min
N.	PAR.	DEF.	MODBUS	MIN... MAX.
46	LA	247	MODBUS address	1... 247
47	Lb	3	MODBUS baud rate	0 = 2,400 baud 1 = 4,800 baud 2 = 9,600 baud 3 = 19,200 baud even

9 ALARMS

COD.	DESCRIPTION	RESET	TO CORRECT
Pr1	regulation probe alarm	automatic	- check P0 - check probe integrity - check electrical connection
AL	temperature alarm	automatic	check A1, A2 and A3
iA	multi-purpose input alarm	automatic	check i5 and i6

10 TECHNICAL SPECIFICATIONS

Purpose of the control device	Operating control	
Construction of the control device	Incorporated control	
Container	Black, self-extinguishing	
Category of heat and fire resistance	D	
Measurements		
75.0 x 33.0 x 59.0 mm (2 15/16 x 1 5/16 x 2 5/16 in) with fixed screw terminal blocks	75.0 x 33.0 x 81.5 mm (2 15/16 x 1 5/16 x 3 3/16 in) with plug-in screw terminal blocks	
Mounting methods for the control device	To be fitted to a panel, snap-in brackets provided	
Degree of protection provided by the covering	IP65 (front)	
Connection method		
Fixed screw terminal blocks for wires up to 2.5 mm ²	Plug-in screw terminal blocks for wires up to 2.5 mm ² (on request)	Pico-Blade connector
Maximum permitted length for connection cables		

Power supply: 10 m (32.8 ft)	Analogue inputs: 10 m (32.8 ft)	
Digital inputs: 10 m (32.8 ft)	Analogue outputs 0-10 V: 10 m (32.8 ft)	
PWM analogue outputs: 1 m (3.28 ft)	Digital outputs: 10 m (32.8 ft)	
Operating temperature	From -5 to 55 °C (from 23 to 131 °F)	
Storage temperature	From -40 to 70 °C (from -40 to 158 °F)	
Operating humidity	Relative humidity without condensate from 10 to 90%	
Pollution status of the control device	2	
Compliance:		
RoHS 2011/65/EC	WEEE 2012/19/EU	REACH (EC) Regulation 1907/2006
EMC 2014/30/EU	LVD 2014/35/EU	
Power supply:		
230 VAC (+10% -15%), 50/60 Hz (±3 Hz), max. 4 VA in EV3... M7		
12-24 VAC/DC (+10% -15%), 50/60 Hz (±3 Hz), max. 5 VA/3W in EV3... M3		
Earthing methods for the control device	None	
Rated impulse-withstand voltage	2.5 KV	
Over-voltage category	II	
Software class and structure	A	
Analogue inputs	1 for PTC, NTC, Pt 100, Pt 1000 or Ni 120 probes, J or K thermocouples, 0-20 mA, 4-20 mA, 0-10 V or 2-10 V transducers (regulation probe)	
PTC probes	Measurement field:	from -50 to 150 °C (from -58 to 302 °F)
	Resolution:	0.1 °C (1 °F)
NTC probes	Measurement field:	from -40 to 110 °C (from -58 to 230 °F)
	Resolution:	0.1 °C (1 °F)
Pt 100 and Pt 1000 probes	Measurement field:	from -100 to 650 °C (from -148 to 999 °F)
	Resolution:	0.1 °C (1 °F)
Ni 120 probes	Measurement field:	from -80 to 300 °C (from -112 to 999 °F)
	Resolution:	0.1 °C (1 °F)
J thermo-couples	Measurement field:	from 0 to 700 °C (from 32 to 999 °F)
	Resolution:	1 °C (1 °F)
K thermo-couples	Measurement field:	from 0 to 999 °C (from 32 to 999 °F)
	Resolution:	1 °C (1 °F)
0-20 mA, 4-20 mA, 0-10 V and 2-10 V transducers:	can be configured	
Digital inputs	1 dry contact (multi-purpose), not available if the analogue input is configured for Pt 100, Pt 1000 or Ni 120 3 wires	
Dry contact	Contact type:	3.3 V, 1 mA
	Protection:	none
Analogue outputs	1 for 0-10 V or PWM signal. Available in the models with power supply 12-24 VAC/DC on condition that they are powered at 24 VAC/DC	
Signal 0-10 V	Minimum applicable impedance	1 KOhm: 2 KOhm in EV3... M7.
	Resolution:	0.01 V
Digital outputs	1 with electromechanical relay (K1 relay)	
K1 relay	SPST, 16 A res. @ 250 VAC	
Type 1 or Type 2 Actions	Type 1	
Additional features of Type 1 or Type 2 actions	C	
Displays	LED display, 3 digit, with function icons	
Alarm buzzer	Built-in	
Communications ports	1 TTL MODBUS slave port for programming key, for EVlink BLE module (app EVconnect) or for serial interface (BMS)	

 N.B.
The device must be disposed of according to local regulations governing the collection of electrical and electronic equipment.

This document and the solutions contained therein are the intellectual property of EVCO and thus protected by the Italian Intellectual Property Rights Code (CPI). EVCO imposes an absolute ban on the full or partial reproduction and disclosure of the content other than with the express approval of EVCO. The customer (manufacturer, installer or end-user) assumes all responsibility for the configuration of the device. EVCO accepts no liability for any possible errors in this document and reserves the right to make any changes, at any time without prejudice to the essential functional and safety features of the equipment.